

CCIE DATA CENTER
ACI CORE

ACI Data, Control & Management Plane

Underlay & Overlay Networks

- **Underlay:** represents the hardware infrastructure.
- **Overlay:** represents the virtual network interconnecting end devices via dynamic tunnels.

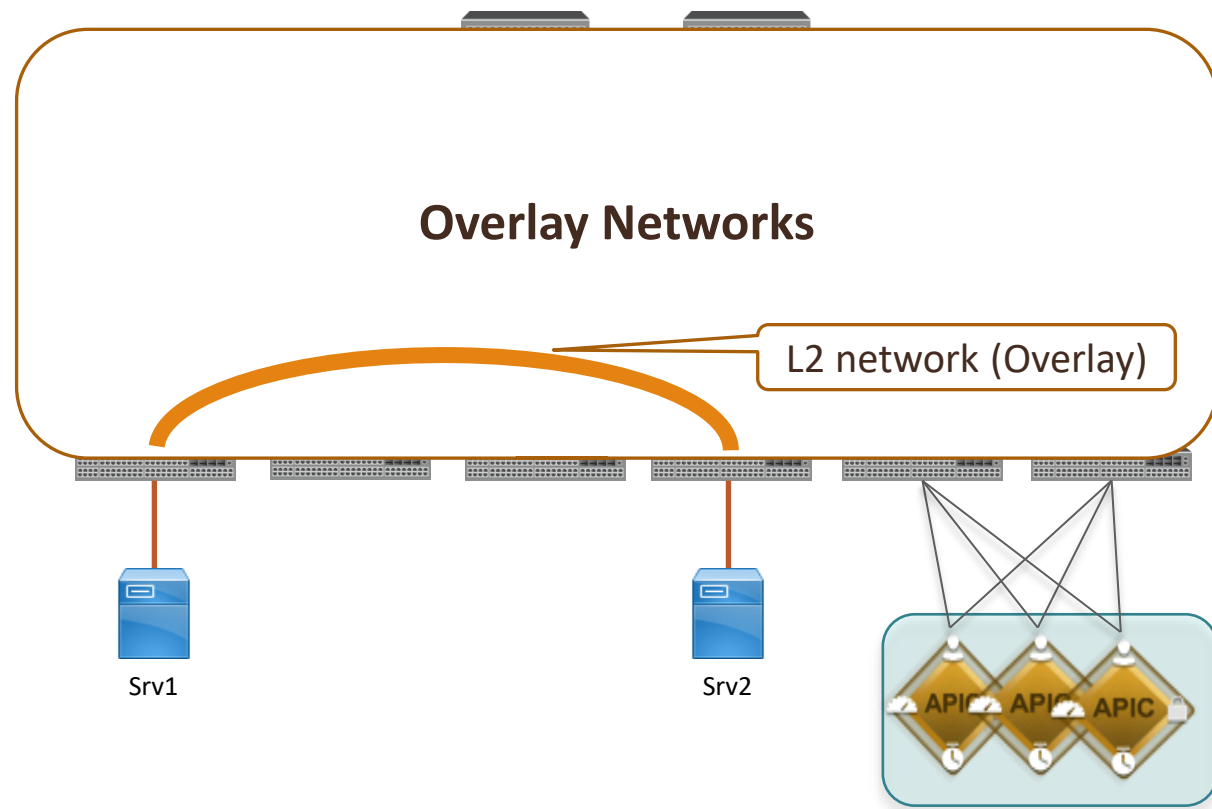

ACI Data Plane

- **iVXLAN** (insieme VXLAN)

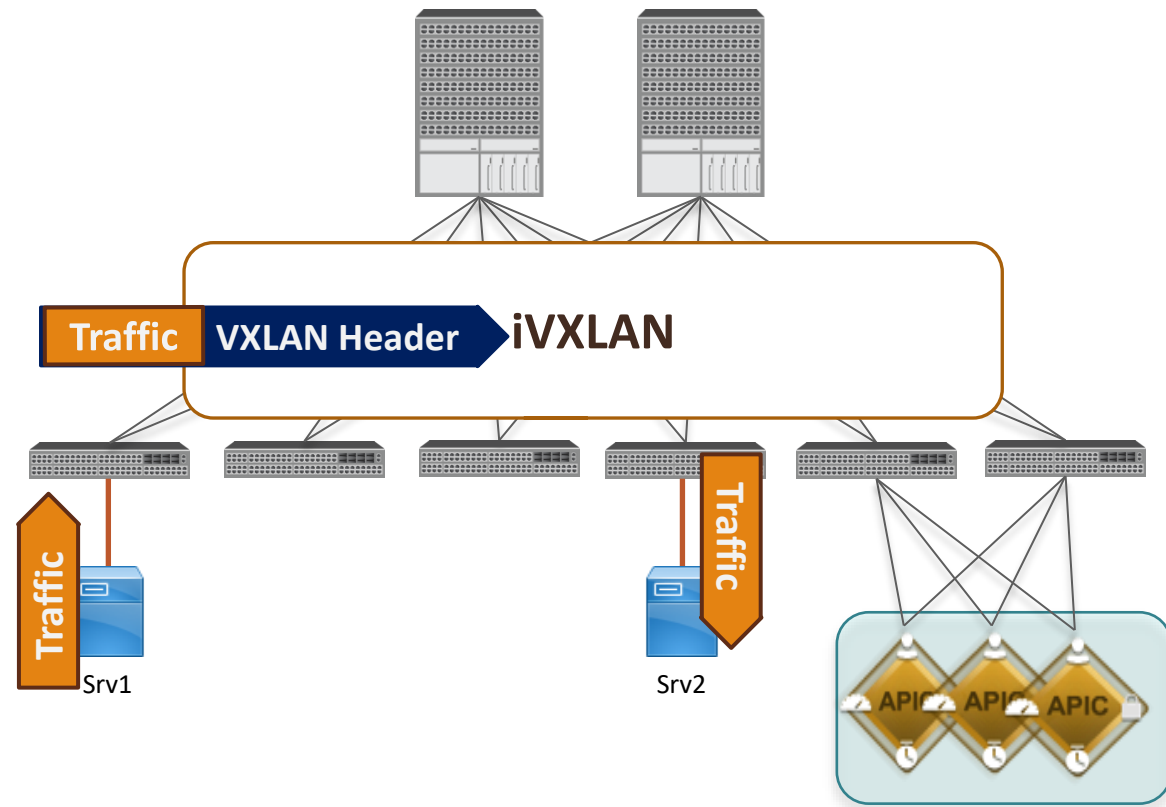

ACI Control Plane Protocols

- LLDP: for fabric discovery.

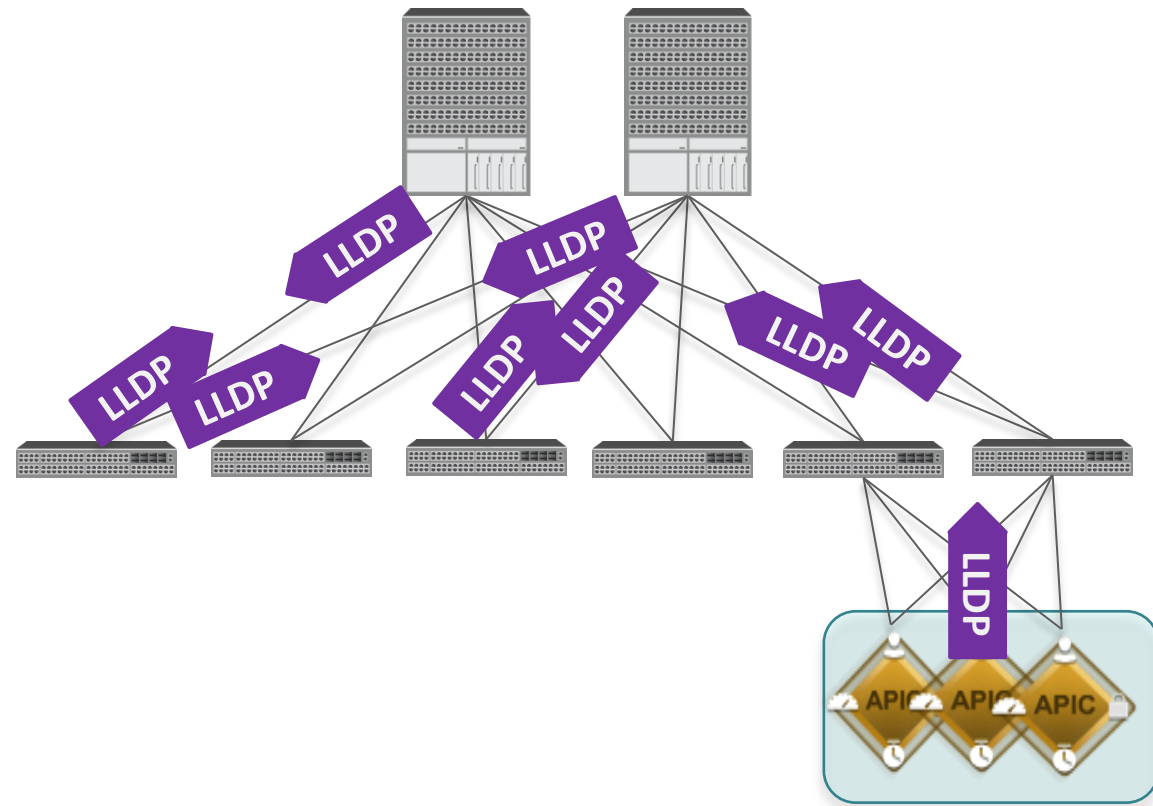

ACI Control Plane Protocols

- **LLDP**: for fabric discovery.
- **DHCP**: for fabric nodes IP settings assignment from APIC.

Infra VRF: overlay-1

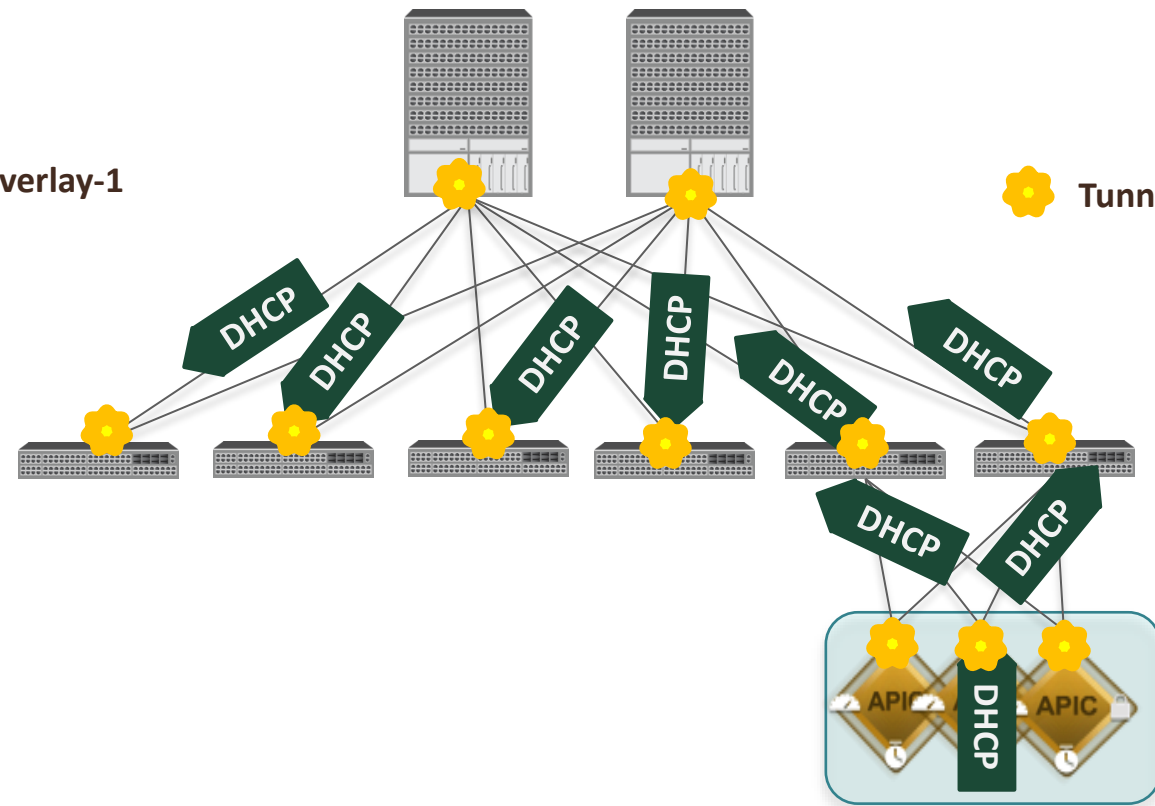

ACI Control Plane Protocols

- **LLDP:** for fabric discovery.
- **DHCP:** for fabric nodes IP settings assignment from APIC.
- **IS-IS:** for VTEPs infra network reachability.

Infra VRF: overlay-1

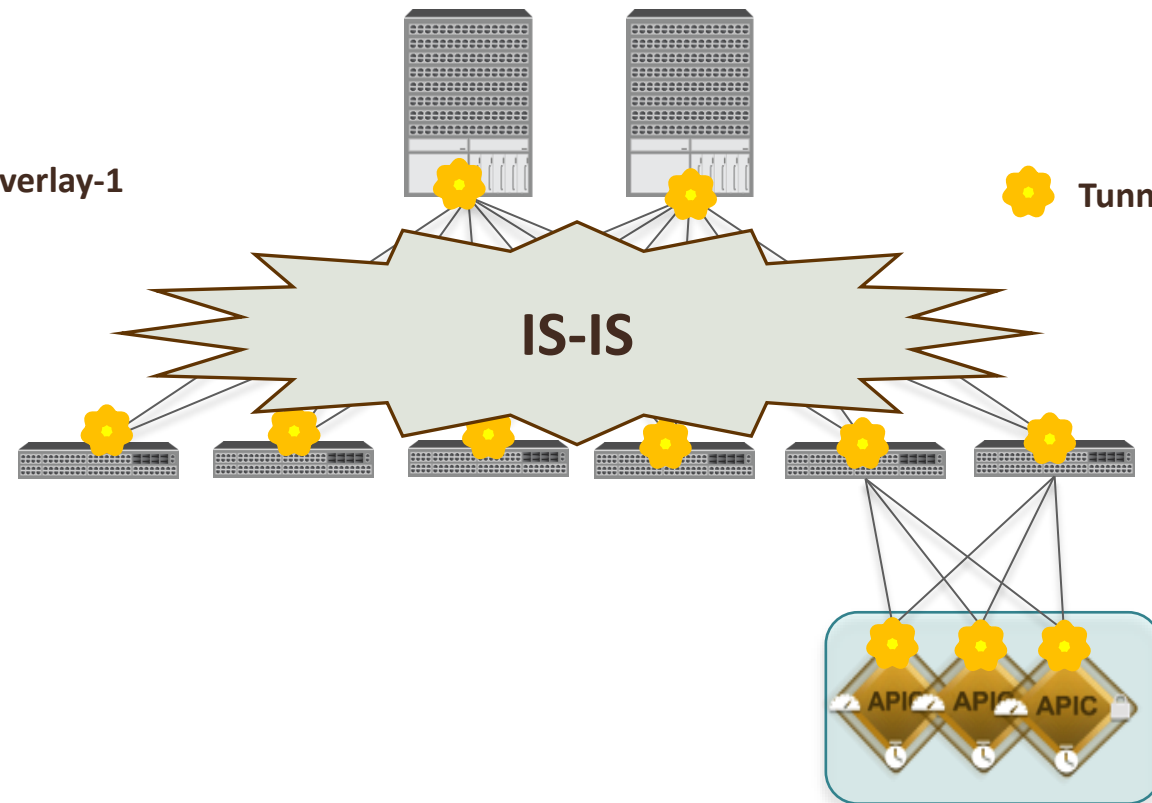

ACI Control Plane Protocols

- **LLDP:** for fabric discovery.
- **DHCP:** for fabric nodes IP settings assignment from APIC.
- **IS-IS:** for VTEPs infra network reachability.
- **COOP:** for endpoints reachability information from the leaf to the spine switches.

Infra VRF: overlay-1

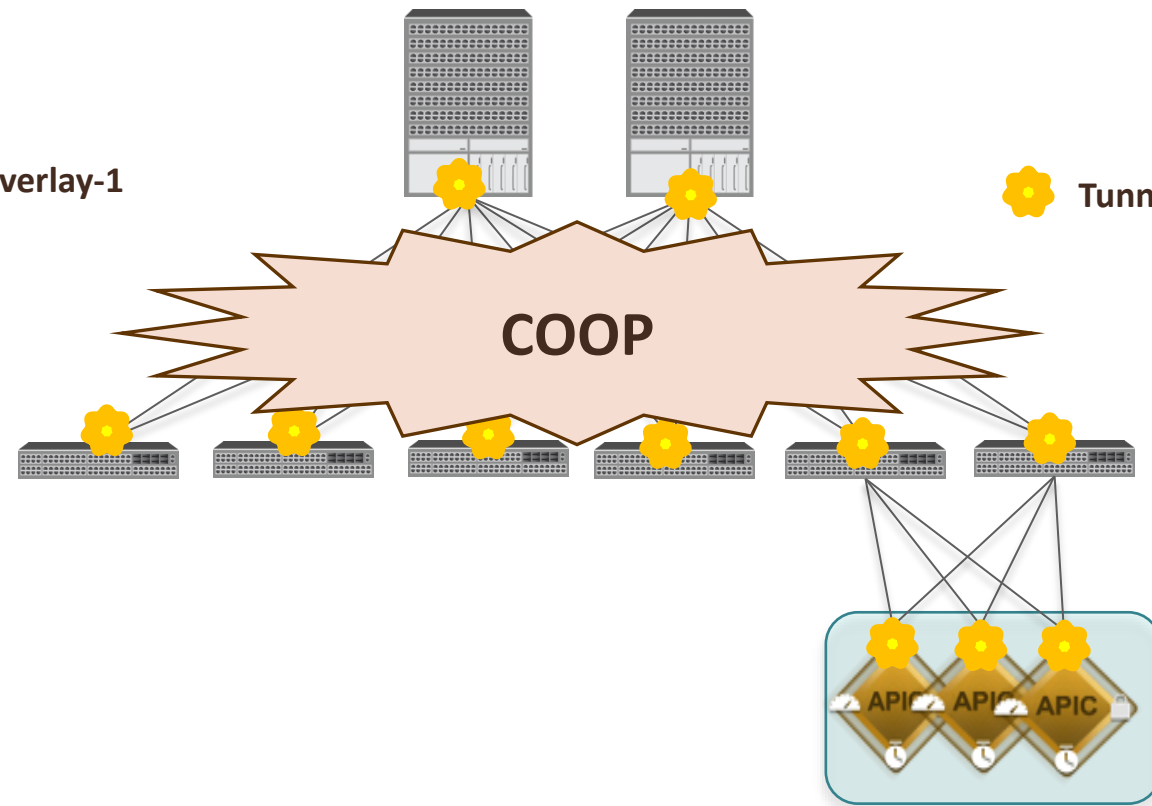

ACI Control Plane Protocols

- **LLDP:** for fabric discovery.
- **DHCP:** for fabric nodes IP settings assignment from APIC.
- **IS-IS:** for VTEPs infra network reachability.
- **COOP:** for endpoints reachability information from the leaf to the spine switches.
- **MP-BGP:** for external route redistribution inside the ACI fabric.

Infra VRF: overlay-1

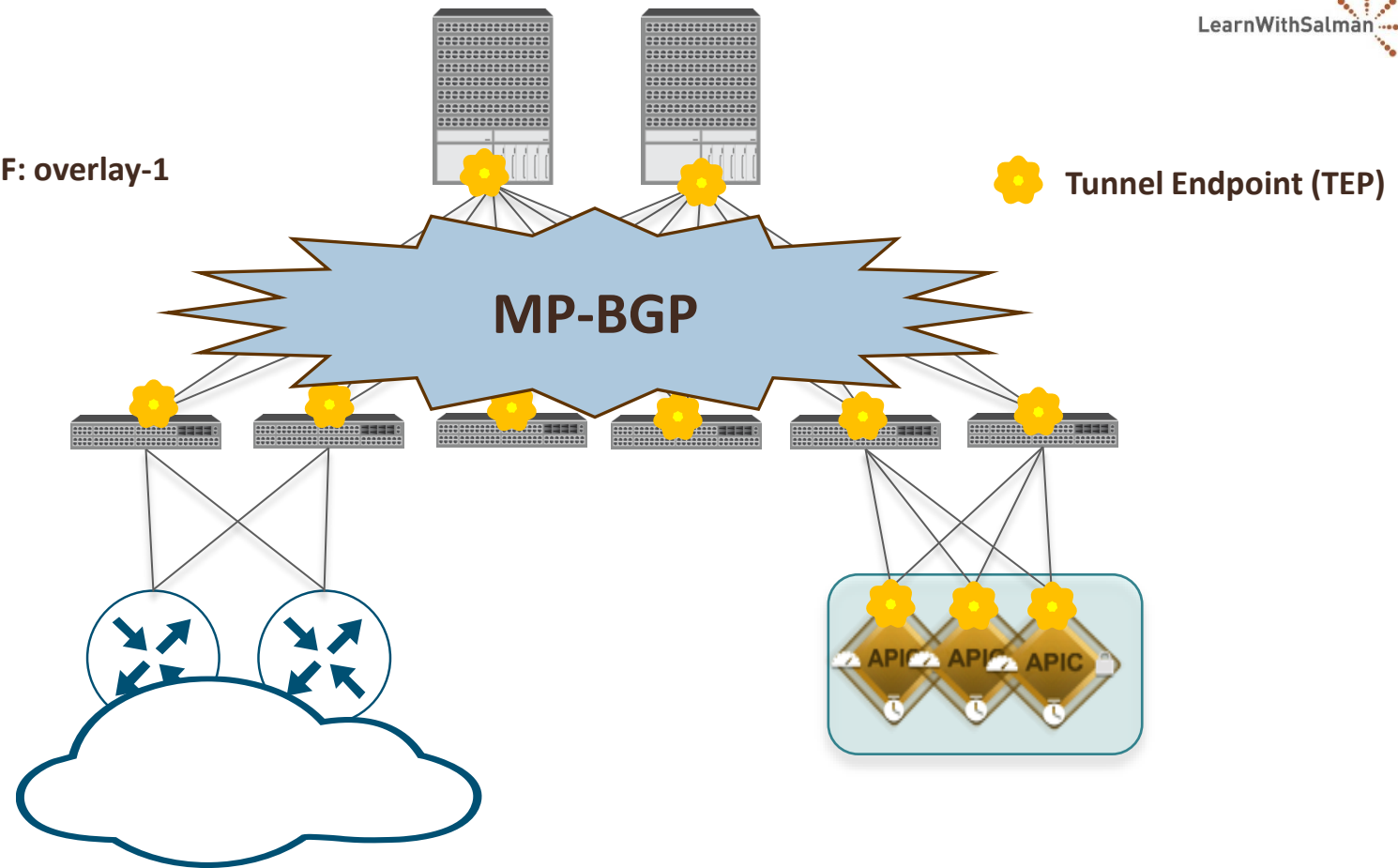

ACI Control Plane Protocols

- **LLDP**: for fabric discovery.
- **DHCP**: for fabric nodes IP settings assignment from APIC.
- **IS-IS**: for VTEPs infra network reachability.
- **COOP**: for endpoints reachability information from the leaf to the spine switches.
- **MP-BGP**: for external route redistribution inside the ACI fabric.
- **IFM**: for policy communication.

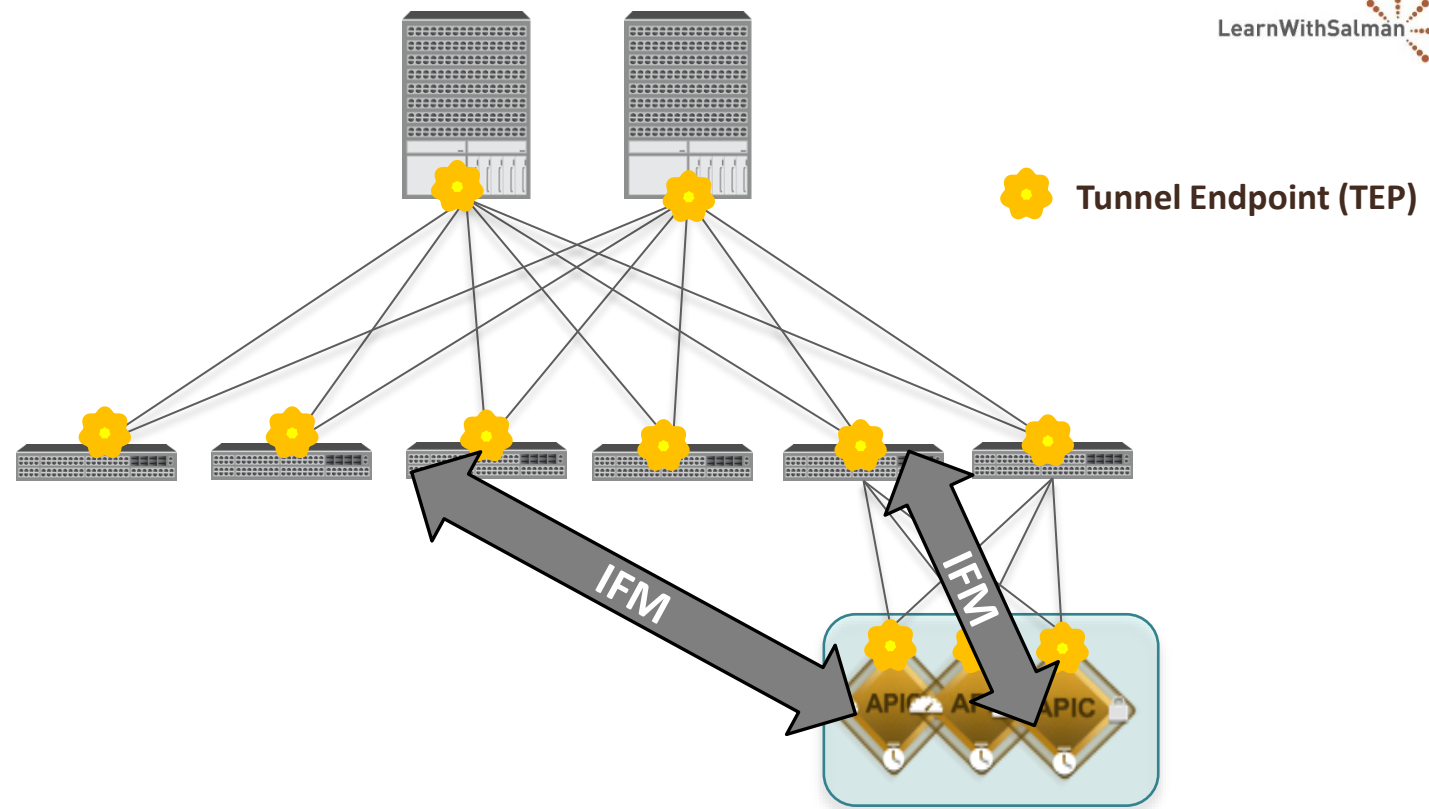

ACI Control Plane Protocols

- **LLDP**: for fabric discovery.
- **DHCP**: for fabric nodes IP settings assignment from APIC.
- **IS-IS**: for VTEPs infra network reachability.
- **COOP**: for endpoints reachability information from the leaf to the spine switches.
- **MP-BGP**: for external route redistribution inside the ACI fabric.
- **IFM**: for policy communication.
- **NTP**: for time sync in the fabric.

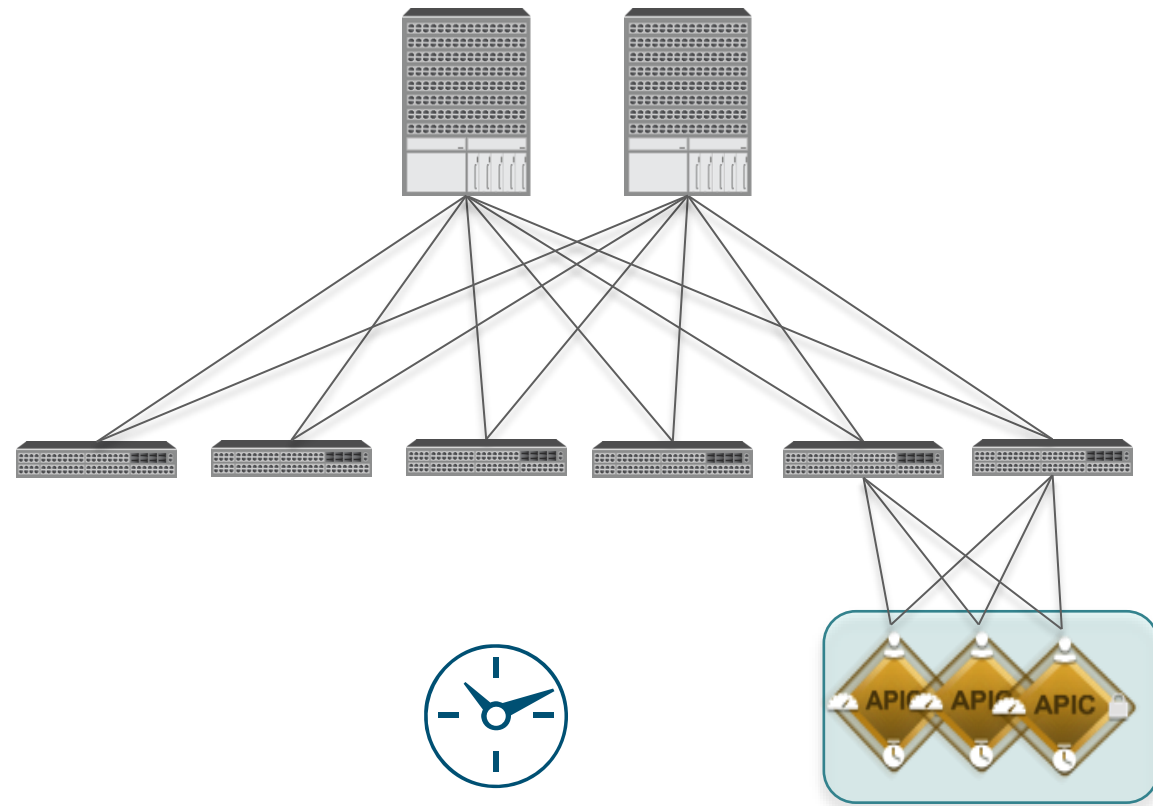

ACI Management Plane

- GUI, CLI & REST API
- Inband (INB) & Out-of-band (OOB)

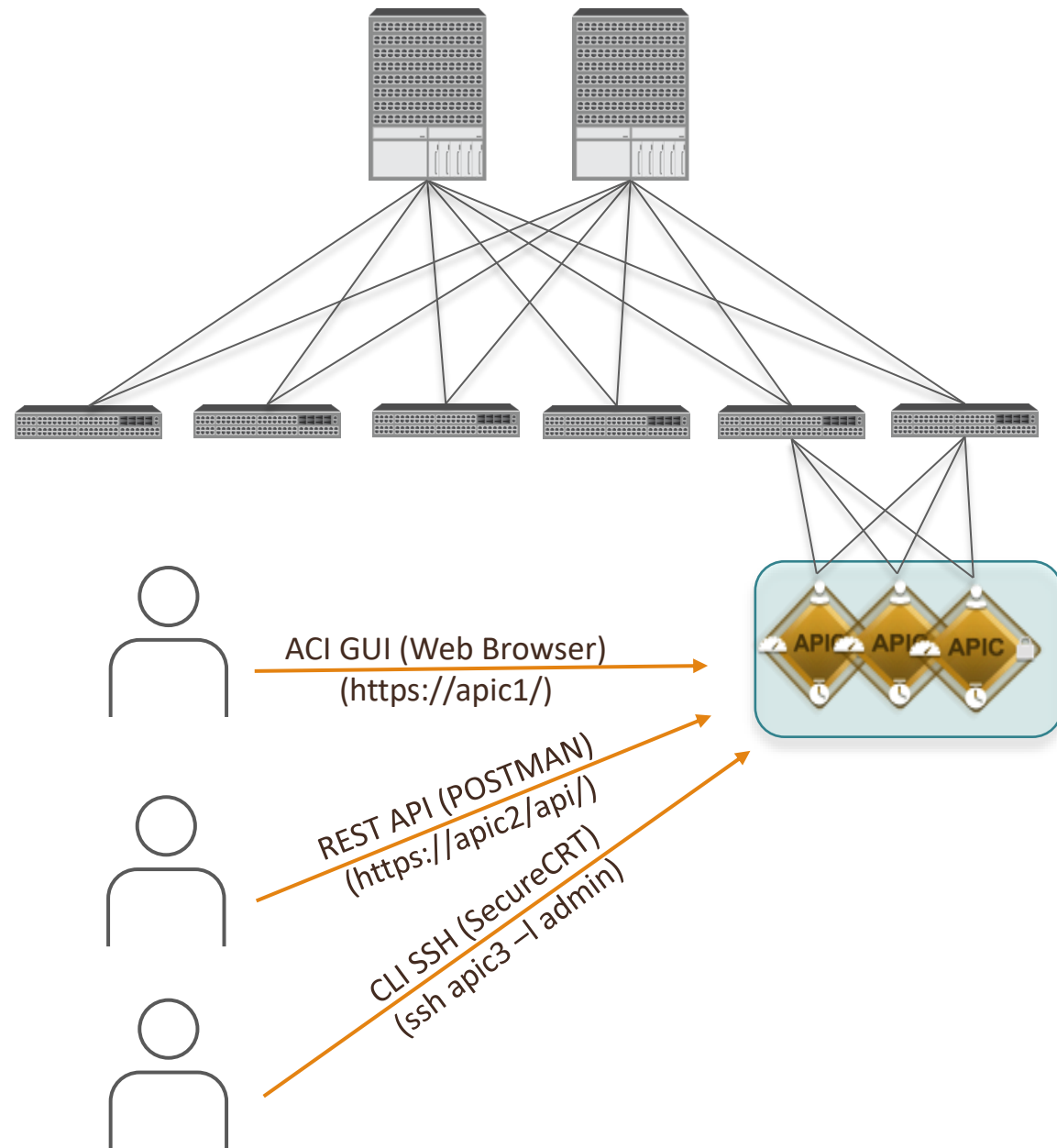

Thanks for watching!

